



1.0 Hz to 100 kHz
Fixed Frequency

32 Pin DIP
8-Pole Filters

Description

The D68 and DP68 Series of small 8-pole fixed-frequency, precision active filters provide high performance linear active filtering in a compact 32-pin DIP package, with a broad range of corner frequencies and a choice of transfer functions. Individual D68 filters can serve in low-pass or high-pass applications (DP68, low-pass only) or be combined to create custom band-pass or band-reject filters. These fully self-contained units require no external components or adjustments. Each model comes factory tuned to a user-specified corner frequency between 1 Hz and 100 kHz (DP68, 1 Hz to 5 kHz) and operate with low total harmonic distortion over a wide dynamic input voltage range from non-critical +/-5V to +/-18V power supplies.



Features/Benefits:

- Low harmonic distortion and wide signal-to-noise ratio to 16 bit resolution.
- Compact 1.8"L x 0.8"W x 0.3"H minimizes board space requirements.
- Plug-in ready-to-use, reducing engineering design and manufacturing cycle time.
- Factory tuned, no external clocks or adjustments needed
- Broad range of transfer characteristics and corner frequencies to meet a wide range of applications.

Applications

- Anti-alias filtering
- Data acquisition systems
- Communication systems and electronics
- Medical electronics equipment and research
- Aerospace, navigation and sonar applications
- Sound and vibration testing
- Acoustic and vibration analysis and control
- Noise elimination
- Signal reconstruction

Available Low-Pass Models:

	Page
D68L8B & DP68L8B	
8-pole Butterworth2
D68L8E & DP68L8E	
8-pole, 6 zero elliptic, 1.77 (-80dB)2
D68L8EX & DP68L8EX	
8-pole, 6 zero elliptic, 1.56 (-80dB)2
D68L8EY & DP68L8EY	
8-pole, 6 zero elliptic, 2.00 (-100dB) . .	.2
D68L8L & DP68L8L	
8-pole Bessel.3
D68L8D60 & DP68L8D60	
8-pole constant delay (-60 dB)3
D68L8D & DP68L8D	
8-pole constant delay (-80 dB)3
D68L8D10 & DP68L8D10	
8-pole constant delay (-100 dB)3

Available High-Pass Models:

D68H8B	8-pole Butterworth4
D68H8E	8-pole, 6 zero elliptic, 1.77 (-80dB)4
D68H8EX	8-pole, 6 zero elliptic, 1.56 (-80dB)4
D68H8EY	8-pole, 6 zero elliptic, 2.00 (-100dB)4

General Specifications:

Pin-out/package data & ordering information5
---	----



Fixed Frequency

8-Pole Low-Pass Filters

Model	D68L8B & DP68L8B	D68L8E & DP68L8E	D68L8EX & DP68L8EX	D68L8EY & DP68L8EY
Product Specifications				
Transfer Function	8-Pole, Butterworth	8-Pole, 6 zero, Elliptic	8-Pole, 6 zero, Elliptic	8-Pole, 6 zero, Elliptic
Size	1.8" x 0.8" x 0.3"	1.8" x 0.8" x 0.3"	1.8" x 0.8" x 0.3"	1.8" x 0.8" x 0.3"
Range fc, fr D68 DP68	1 Hz to 100 kHz 1 Hz to 5 kHz	1 Hz to 100 kHz 1 Hz to 5 kHz	1 Hz to 100 kHz 1 Hz to 5 kHz	1 Hz to 100 kHz 1 Hz to 5 kHz
Theoretical Transfer Characteristics	Appendix A Page 9	Appendix A Page 24	Appendix A Page 23	Appendix A Page 25
Passband Ripple (theoretical)	0.0 dB	± 0.035 dB	-0.05 dB	-0.05 dB
DC Voltage Gain (non-inverting)	0 ± 0.1 dB max. 0 ± 0.05 dB typ.	0 ± 0.1 dB max. 0 ± 0.05 dB typ.	0 ± 0.1 dB max. 0 ± 0.05 dB typ.	0 ± 0.1 dB max. 0 ± 0.05 dB typ.
Stopband Attenuation Rate	48 dB/octave	80 dB min.	80 dB min.	100 dB min.
Cutoff Frequency Stability Amplitude Phase	fc ± 1% max. ± 0.01% /°C -3 dB -360°	fr ± 1% max. ± 0.01% /°C -0.035 dB -323.5°	fr ± 1% max. ± 0.01% /°C -0.05 dB -414°	fr ± 2% max. ± 0.01% /°C -0.05 dB -419°
Filter Attenuation (theoretical)	0.12 dB 0.80 fc 3.01 dB 1.00 fc 60.0 dB 2.37 fc 80.0 dB 3.16 fc	0.035 dB 1.00 fr 3.01 dB 1.13 fr 60.0 dB 1.67 fr 80.0 dB 1.77 fr	0.05 dB 1.00 fr 3.01 dB 1.05 fr 60.0 dB 1.45 fr 80.0 dB 1.56 fr	0.05 dB 1.00 fr 3.01 dB 1.06 fr 80.0 dB 1.83 fr 100.0 dB 2.00 fr
Phase Match¹	0 - 0.8 fc ± 2° max. ± 1° typ. 0.8 fc - 1.0 fc ± 3° max. ± 1.5° typ.	0 - 0.8 fr ± 2° max. ± 1° typ. 0.8 fr - 1.0 fr ± 4° max. ± 2° typ.	0 - 0.8 fr ± 3° max. ± 1.5° typ. 0.8 fr - 1.0 fr ± 4° max. ± 2° typ.	0 - 0.8 fr ± 3° max. ± 1.5° typ. 0.8 fr - 1.0 fr ± 4° max. ± 2° typ.
Amplitude Accuracy (theoretical)	0 - 0.8 fc ± 0.2 dB max. ± 0.1 dB typ. 0.8 fc - 1.0 fc ± 0.3 dB max. ± 0.15 dB typ.	0 - 0.8 fr ± 0.2 dB max. ± 0.1 dB typ. 0.8 fr - 1.0 fr ± 0.3 dB max. ± 0.15 dB typ.	0 - 0.8 fr ± 0.2 dB max. ± 0.1 dB typ. 0.8 fr - 1.0 fr ± 0.5 dB max. ± 0.25 dB typ.	0 - 0.8 fr ± 0.2 dB max. ± 0.1 dB typ. 0.8 fr - 1.0 fr ± 0.5 dB max. ± 0.25 dB typ.
Total Harmonic Distortion @ 1 kHz D68 DP68	<-100 dB typ. <-80 dB typ.	<-88 dB typ. <-80 dB typ.	<-88 dB typ. <-80 dB typ.	<-88 dB typ. <-80 dB typ.
Wide Band Noise (5 Hz - 2 MHz)	200 µVrms typ.	200 µVrms typ.	250 µVrms typ.	250 µVrms typ.
Narrow Band Noise (20 Hz - 100 kHz)	50 µVrms typ.	50 µVrms typ.	75 µVrms typ.	75 µVrms typ.
Filter Mounting Assembly	FMA-01A	FMA-01A	FMA-01A	FMA-01A

1. Unit to unit match for the same transfer function, set to the same frequency and operating configuration, and from the same manufacturing lot.



Model	D68L8L & DP68L8L	D68L8D60 & DP68L8D60	D68L8D & DP68L8D	D68L8D10 & DP68L8D10
Product Specifications				
Transfer Function	8-Pole, Bessel	8-Pole, 6 zero, Constant Delay	8-Pole, 6 zero, Constant Delay	8-Pole, 6 zero, Constant Delay
Size	1.8" x 0.8" x 0.3"	1.8" x 0.8" x 0.3"	1.8" x 0.8" x 0.3"	1.8" x 0.8" x 0.3"
Range f_c D68 DP68	1 Hz to 100 kHz 1 Hz to 5 kHz	1 Hz to 100 kHz 1 Hz to 5 kHz	1 Hz to 100 kHz 1 Hz to 5 kHz	1 Hz to 100 kHz 1 Hz to 5 kHz
Theoretical Transfer Characteristics	Appendix A Page 4	Appendix A Page 20	Appendix A Page 21	Appendix A Page 22
Passband Ripple (theoretical)	0.0 dB	0.15 dB	0.15 dB	0.15 dB
DC Voltage Gain (non-inverting)	0 ± 0.1 dB max. 0 ± 0.05 dB typ.	0 ± 0.1 dB max. 0 ± 0.05 dB typ.	0 ± 0.1 dB max. 0 ± 0.05 dB typ.	0 ± 0.1 dB max. 0 ± 0.05 dB typ.
Stopband Attenuation Rate	48 dB/octave	60 dB min.	80 dB min.	100 dB min.
Cutoff Frequency Stability Amplitude Phase	f _c ± 1% max. ± 0.01% /°C -3dB -182°	f _c ± 1% max. ± 0.01% /°C -3dB -306°	f _c ± 1% max. ± 0.01% /°C -3dB -306°	f _c ± 2% max. ± 0.01% /°C -3dB -311°
Filter Attenuation (theoretical)	1.91 dB 0.80 f _c 3.01 dB 1.00 f _c 60.0 dB 4.52 f _c 80.0 dB 6.07 f _c	3.01 dB 1.00 f _c 40.0 dB 2.28 f _c 60.0 dB 2.64 f _c	3.01 dB 1.00 f _c 60.0 dB 3.08 f _c 80.0 dB 3.57 f _c	3.01 dB 1.00 f _c 80.0 dB 4.45 f _c 100.0 dB 5.20 f _c
Phase Match¹	0 - f _c ± 2° max. ± 1° typ.	0 - f _c ± 2° max. ± 1° typ.	0 - f _c ± 2° max. ± 1° typ.	0 - f _c ± 2° max. ± 1° typ.
Amplitude Accuracy (theoretical)	0 - f _c ± 0.2 dB max. ± 0.1 dB typ.	0 - 0.8 f _c ± 0.2 dB max. ± 0.1 dB typ. 0.8 f _c - 1.0 f _c ± 0.3 dB max. ± 0.15 dB typ.	0 - 0.8 f _c ± 0.2 dB max. ± 0.1 dB typ. 0.8 f _c - 1.0 f _c ± 0.3 dB max. ± 0.15 dB typ.	0 - 0.8 f _c ± 0.2 dB max. ± 0.1 dB typ. 0.8 f _c - 1.0 f _c ± 0.3 dB max. ± 0.15 dB typ.
Total Harmonic Distortion @ 1 kHz D68 DP68	<-100 dB typ. <-80 dB typ.	<-100 dB typ. <-80 dB typ.	<-100 dB typ. <-80 dB typ.	<-100 dB typ. <-80 dB typ.
Wide Band Noise (5 Hz - 2 MHz)	200 μVrms typ.	200 μVrms typ.	200 μVrms typ.	200 μVrms typ.
Narrow Band Noise (20 Hz - 100 kHz)	50 μVrms typ.	50 μVrms typ.	50 μVrms typ.	50 μVrms typ.
Filter Mounting Assembly	FMA-01A	FMA-01A	FMA-01A	FMA-01A

1. Unit to unit match for the same transfer function, set to the same frequency and operating configuration, and from the same manufacturing lot.



Fixed Frequency

8-Pole High-Pass Filters

Model	D68H8B	D68H8E	D68H8EX	D68H8EY
Product Specifications				
Transfer Function	8-Pole, Butterworth	8-Pole, 6 Zero, Elliptic	8-Pole, 6 Zero, Elliptic	8-Pole, 6 zero, Elliptic
Size	1.8" x 0.8" x 0.3"	1.8" x 0.8" x 0.3"	1.8" x 0.8" x 0.3"	1.8" x 0.8" x 0.3"
Range f_c, fr D68 DP68	1 Hz to 100 kHz Not Available	1 Hz to 100 kHz Not Available	1 Hz to 100 kHz Not Available	1 Hz to 100 kHz Not Available
Theoretical Transfer Characteristics	Appendix A Page 29	Appendix A Page 37	Appendix A Page 36	Appendix A Page 38
Passband Ripple (theoretical)	0.0 dB	± 0.035 dB	-0.05 dB	-0.05 dB
Voltage Gain (non-inverting)	0 ± 0.2 dB to 100 kHz 0 ± 0.5 dB to 120 kHz	0 ± 0.2 dB to 100 kHz 0 ± 0.5 dB to 120 kHz	0 ± 0.2 dB to 100 kHz 0 ± 0.5 dB to 120 kHz	0 ± 0.2 dB to 100 kHz 0 ± 0.5 dB to 120 kHz
Stopband Attenuation Rate	48 dB/octave	80 dB	80 dB	100 dB
Power Bandwidth	120 kHz	120 kHz	120 kHz	120 kHz
Small Signal Bandwidth	(-6dB) 1 MHz	(-6dB) 1 MHz	(-6dB) 1 MHz	(-6dB) 1 MHz
Cutoff Frequency Stability Amplitude Phase	$f_c \pm 1\%$ max. $\pm 0.01\%$ /°C -3 dB -360°	$f_r \pm 1\%$ max. $\pm 0.01\%$ /°C -0.035 dB -323.5°	$f_r \pm 1\%$ max. $\pm 0.01\%$ /°C -0.05 dB -414°	$f_r \pm 2\%$ max. $\pm 0.01\%$ /°C -0.05 dB -419°
Filter Attenuation (theoretical)	80.0 dB 0.31 f_c 60.0 dB 0.42 f_c 3.01 dB 1.00 f_c 0.00 dB 2.00 f_c	80.0 dB 0.56 f_r 60.0 dB 0.60 f_r 3.01 dB 0.88 f_r 0.03 dB 1.00 f_r 0.00 dB 2.00 f_r	80.0 dB 0.64 f_r 60.0 dB 0.69 f_r 3.01 dB 0.95 f_r 0.05 dB 1.00 f_r 0.00 dB 2.00 f_r	100.0 dB 0.50 f_r 80.0 dB 0.55 f_r 3.01 dB 0.94 f_r 0.03 dB 1.00 f_r 0.00 dB 2.00 f_r
Phase Match¹	$f_c - 100$ kHz $\pm 3^\circ$ max. $\pm 1.5^\circ$ typ.	0 - 1.25 f_r $\pm 4^\circ$ max. $\pm 2^\circ$ typ. 1.25 f_r -100 kHz $\pm 2^\circ$ max. $\pm 1^\circ$ typ.	0 - 1.25 f_r $\pm 4^\circ$ max. $\pm 2^\circ$ typ. 1.25 f_r -100 kHz $\pm 2^\circ$ max. $\pm 1^\circ$ typ.	0 - 1.25 f_r $\pm 4^\circ$ max. $\pm 2^\circ$ typ. 1.25 f_r -100 kHz $\pm 3^\circ$ max. $\pm 1.5^\circ$ typ.
Amplitude Accuracy (theoretical)	1.0 - 1.25 f_c ± 0.3 dB max. ± 0.15 dB typ. 1.25 f_c -100 kHz ± 0.2 dB max. ± 0.1 dB typ.	1.00 - 1.25 f_r ± 0.3 dB max. ± 0.15 dB typ. 1.25 f_r -100 kHz ± 0.2 dB max. ± 0.1 dB typ.	1.00 - 1.25 f_r ± 0.5 dB max. ± 0.25 dB typ. 1.25 f_r -100 kHz ± 0.2 dB max. ± 0.1 dB typ.	1.00 - 1.25 f_r ± 0.5 dB max. ± 0.25 dB typ. 1.25 f_r -100 kHz ± 0.2 dB max. ± 0.1 dB typ.
Total Harmonic Distortion @ 1 kHz D68	<-88 dB typ.	<-88 dB typ.	<-88 dB typ.	<-88 dB typ.
Wide Band Noise (5 Hz - 2 MHz)	400 μ Vrms	400 μ Vrms typ.	500 μ Vrms typ.	500 μ Vrms typ.
Narrow Band Noise (20 Hz - 100 kHz)	100 μ Vrms typ.	100 μ Vrms typ.	150 μ Vrms typ.	150 μ Vrms typ.
Filter Mounting Assembly	FMA-01A	FMA-01A	FMA-01A	FMA-01A

1. Unit to unit match for the same transfer function, set to the same frequency and operating configuration, and from the same manufacturing lot.



Specification

(25°C and Vs ± 15 Vdc)

Pin-Out and Package Data Ordering Information

Analog Input Characteristics¹

Impedance	10 kΩ min.
Voltage Range	± 10 V _{peak}
Max. Safe Voltage	± Vs

Analog Output Characteristics

Impedance(Closed Loop)	1 Ω typ. 10 Ω max.
Linear Operating Range	± 10 V
Maximum Current ²	± 2 mA
Offset Voltage ³	2 mV typ. 20 mV max.
Offset Temp. Coeff.	50 μV / °C

Power Supply (±V)

Rated Voltage	± 15 Vdc
Operating Range	± 5 to ± 18 Vdc
Maximum Safe Voltage	± 18 Vdc
Quiescent Current D68	

± 25 mA typ.
± 40 mA max.

Quiescent Current DP68

± 7 mA typ.
± 10 mA max.

Temperature

Operating	0 to + 70 °C
Storage	- 25 to + 85 °C

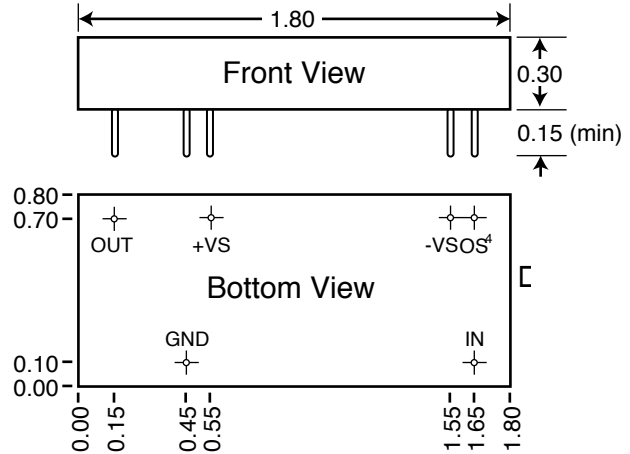
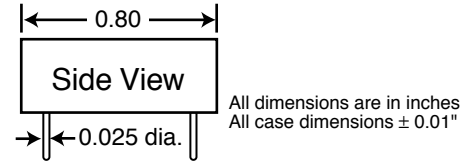
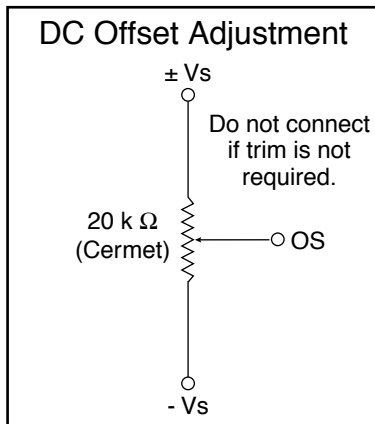

Filter Mounting Assembly-See FMA-01A

Ordering Information

Filter Type	Transfer Function
L - Low Pass	B - Butterworth
H - High Pass	L - Bessel
	D - constant delay (-80 dB)
	D60 - constant delay (-60 dB)
	D10 - constant delay (-100 dB)
	E - elliptic 1.77 (-80 dB)
	EX - elliptic 1.56 (-80 dB)
	EY - elliptic 2.00 (-100 dB)

D68L8B-849 Hz

Power Level

D - Standard Power

DP - Low Power

Notes:

1. Input and output signal voltage referenced to supply common.
2. Output is short circuit protected to common. DO NOT CONNECT TO ±Vs.
3. Adjustable to zero.
4. Units operate with or with out offset pin connected.
5. How to Specify Corner Frequency:

Corner frequencies are specified by attaching a three digit frequency designator to the basic model number. Corner frequencies can range from 1.00 Hz to 100 kHz.

- 3 dB Corner Frequency⁵

e.g., 849 Hz

2.50 kHz

33.3 kHz



Appendix A

Theoretical Transfer Characteristics

f/fc (Hz)	Amp (dB)	Phase (deg)	Delay ¹ (sec)
0.00	0.00	0.00	.506
0.10	-0.029	-18.2	.506
0.20	-0.117	-36.4	.506
0.30	-0.264	-54.7	.506
0.40	-0.470	-72.9	.506
0.50	-0.737	-91.1	.506
0.60	-1.06	-109	.506
0.70	-1.45	-128	.506
0.80	-1.91	-146	.506
0.85	-2.16	-155	.506
0.90	-2.42	-164	.506
0.95	-2.71	-173	.506
1.00	-3.01	-182	.506
1.10	-3.67	-200	.506
1.20	-4.40	-219	.506
1.30	-5.20	-237	.506
1.40	-6.10	-255	.505
1.50	-7.08	-273	.504
1.60	-8.16	-291	.502
1.70	-9.36	-309	.498
1.80	-10.7	-327	.492
1.90	-12.1	-345	.482
2.00	-13.7	-362	.468
2.25	-18.1	-402	.417
2.50	-23.1	-436	.352
2.75	-28.3	-465	.291
3.00	-33.4	-489	.241
3.25	-38.3	-509	.201
3.50	-43.1	-526	.170
4.00	-51.8	-552	.126
5.00	-66.8	-587	.077
6.00	-79.2	-610	.052
7.00	-89.8	-626	.038
8.00	-99.0	-638	.029
9.00	-107	-647	.023
10.0	-114	-655	.018

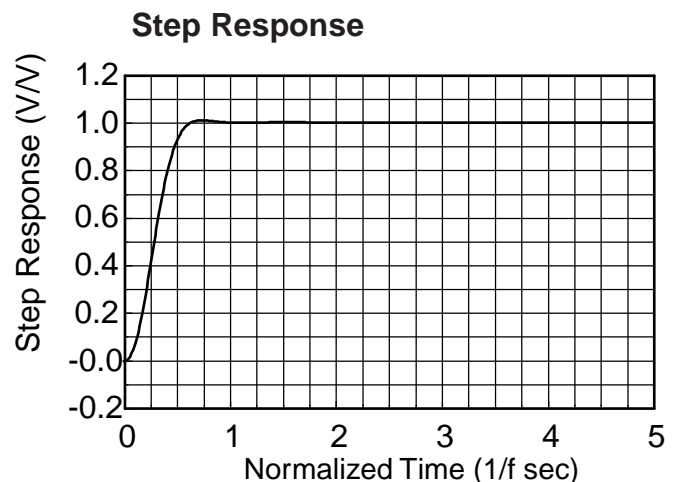
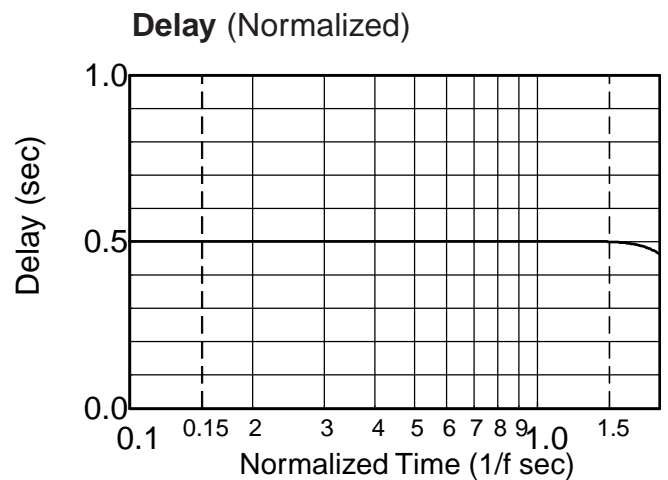
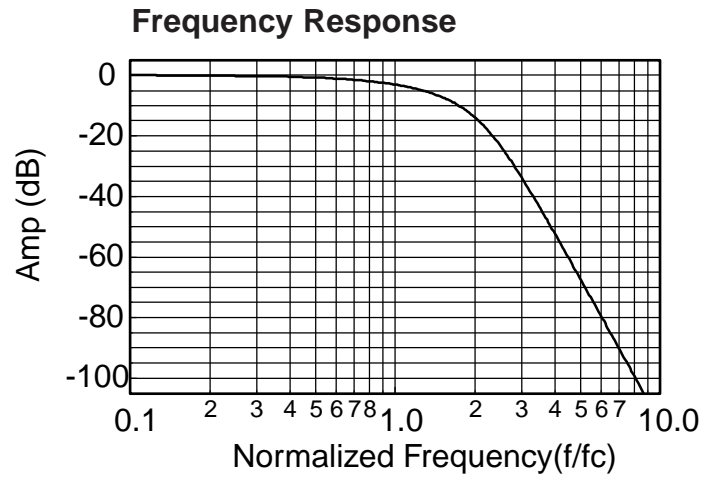

1. Normalized Group Delay:

The above delay data is normalized to a corner frequency of 1.0Hz. The actual delay is the normalized delay divided by the actual corner frequency (fc).

$$\text{Actual Delay} = \frac{\text{Normalized Delay}}{\text{Actual Corner Frequency (fc) in Hz}}$$



Appendix A

Theoretical Transfer Characteristics

f/fc (Hz)	Amp (dB)	Phase (deg)	Delay ¹ (sec)
0.00	0.00	0.00	.816
0.10	0.00	-29.4	.819
0.20	0.00	-59.0	.828
0.30	0.00	-89.1	.843
0.40	0.00	-120	.867
0.50	0.00	-152	.903
0.60	-0.001	-185	.956
0.70	-0.014	-221	1.04
0.80	-0.121	-261	1.19
0.85	-0.311	-283	1.29
0.90	-0.738	-307	1.40
0.95	-1.58	-333	1.48
1.00	-3.01	-360	1.46
1.10	-7.48	-408	1.17
1.20	-12.9	-445	.873
1.30	-18.2	-472	.672
1.40	-23.4	-494	.540
1.50	-28.2	-511	.448
1.60	-32.7	-526	.380
1.70	-36.9	-539	.328
1.80	-40.8	-550	.287
1.90	-44.6	-560	.253
2.00	-48.2	-568	.226
2.25	-56.3	-586	.174
2.50	-63.7	-600	.139
2.75	-70.3	-611	.113
3.00	-76.3	-621	.094
3.25	-81.9	-629	.080
3.50	-87.1	-635	.069
4.00	-96.3	-646	.052
5.00	-112	-661	.033
6.00	-125	-671	.023
7.00	-135	-678	.017
8.00	-144	-683	.013
9.00	-153	-687	.010
10.0	-160	-691	.008

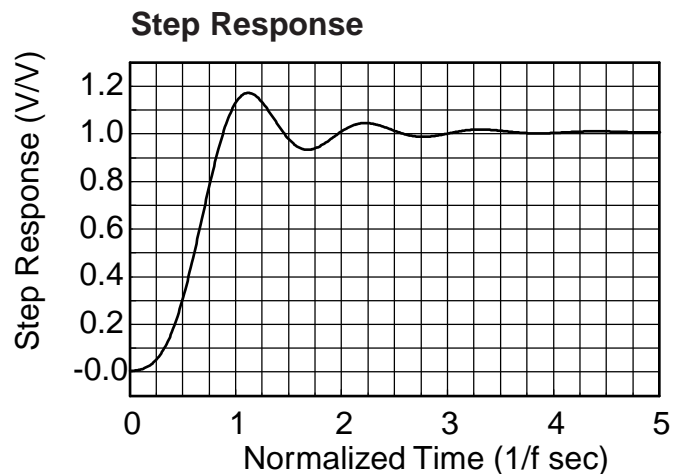
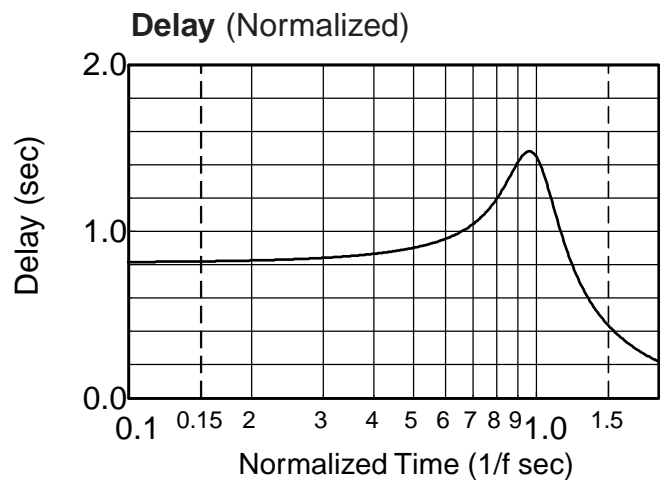
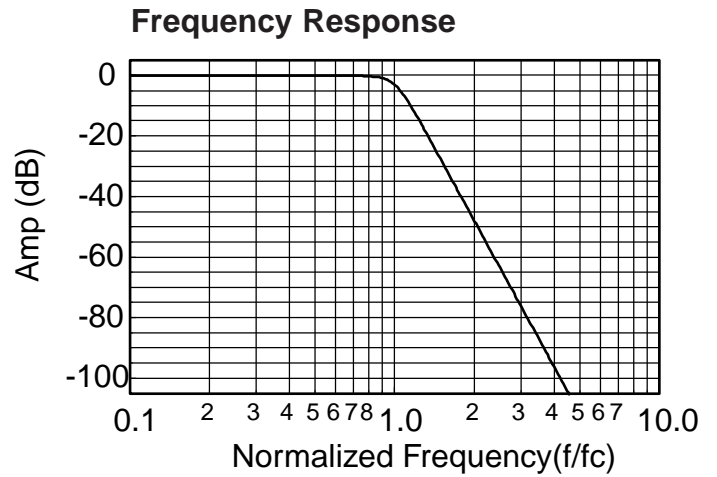

1. Normalized Group Delay:

The above delay data is normalized to a corner frequency of 1.0Hz. The actual delay is the normalized delay divided by the actual corner frequency (fc).

$$\text{Actual Delay} = \frac{\text{Normalized Delay}}{\text{Actual Corner Frequency (fc) in Hz}}$$



Appendix A

Theoretical Transfer Characteristics

f/fc (Hz)	Amp (dB)	Phase (deg)	Delay ¹ (sec)
0.00	0.00	0.00	.776
0.10	0.005	-28.0	.776
0.20	0.012	-55.9	.776
0.30	0.005	-83.9	.776
0.40	-0.042	-112	.776
0.50	-0.161	-140	.776
0.60	-0.384	-168	.776
0.70	-0.745	-196	.776
0.80	-1.28	-224	.776
0.85	-1.62	-238	.776
0.90	-2.02	-252	.776
0.95	-2.48	-265	.775
1.00	-3.01	-279	.773
1.10	-4.29	-307	.766
1.20	-5.91	-334	.749
1.40	-10.3	-386	.675
1.60	-15.9	-431	.558
1.80	-22.4	-467	.443
2.00	-29.4	-495	.351
2.25	-39.0	-523	.268
2.50	-50.5	-544	.212
2.75	-78.0	-561	.171
3.00	-63.7	-395	.142
3.25	-63.5	-407	.119
3.50	-66.9	-417	.102
3.75	-74.7	-425	.088
4.00	-85.0	-253	.077
4.25	-72.0	-259	.068
4.50	-67.9	-265	.060
4.75	-65.8	-270	.054
5.00	-64.6	-275	.048
5.25	-63.9	-279	.044
5.50	-63.5	-283	.040
5.75	-63.3	-286	.036
6.00	-63.2	-289	.033
6.50	-63.3	-295	.028
7.00	-63.7	-299	.024
8.00	-64.7	-307	.019
9.00	-66.0	-313	.015
10.0	-67.3	-318	.012

1. Normalized Group Delay:

The above delay data is normalized to a corner frequency of 1.0Hz. The actual delay is the normalized delay divided by the actual corner frequency (fc).

$$\text{Actual Delay} = \frac{\text{Normalized Delay}}{\text{Actual Corner Frequency (fc) in Hz}}$$

Frequency Response

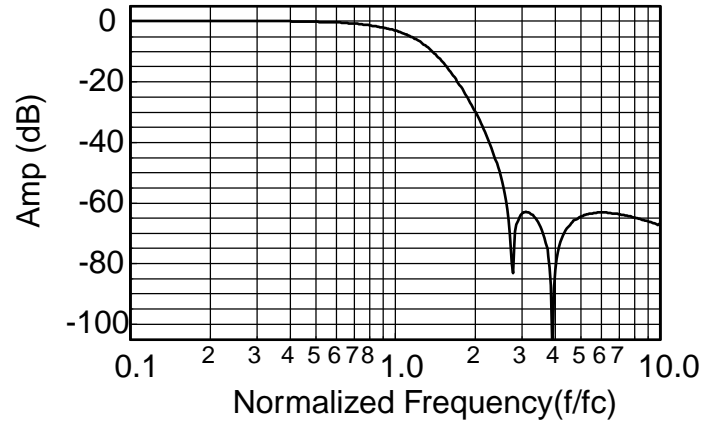

Delay (Normalized)

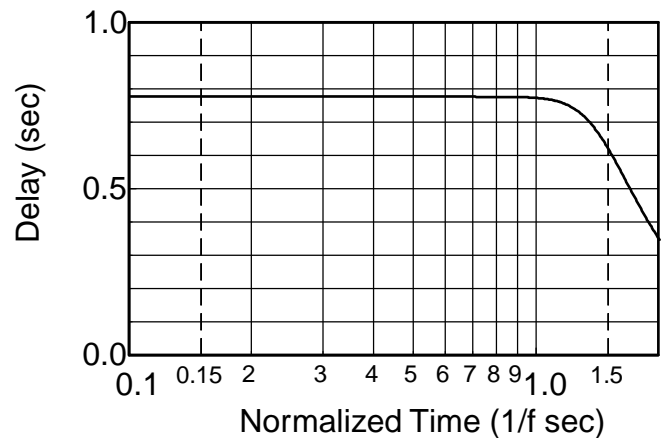

Step Response

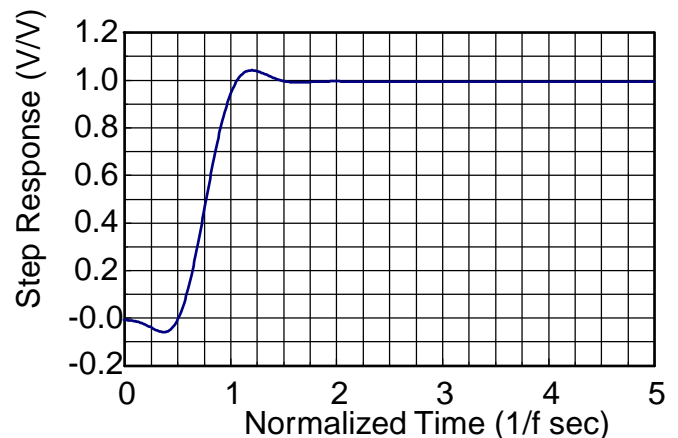



Appendix A

Theoretical Transfer Characteristics

f/fc (Hz)	Amp (dB)	Phase (deg)	Delay ¹ (sec)
0.00	0.00	0.00	.852
0.10	0.017	-30.7	.852
0.20	0.058	-61.3	.852
0.30	0.099	-92.0	.852
0.40	0.105	-123	.852
0.50	0.034	-153	.852
0.60	-0.157	-184	.852
0.70	-0.510	-215	.852
0.80	-1.07	-245	.851
0.85	-1.44	-261	.850
0.90	-1.89	-276	.849
0.95	-2.41	-291	.846
1.00	-3.01	-306	.841
1.10	-4.50	-336	.821
1.20	-6.39	-365	.783
1.40	-11.3	-417	.656
1.60	-17.1	-459	.512
1.80	-23.2	-492	.396
2.00	-29.1	-517	.312
2.25	-36.3	-542	.239
2.50	-43.4	-561	.189
2.75	-50.3	-576	.153
3.00	-57.6	-589	.127
3.25	-62.5	-599	.107
3.50	-75.4	-608	.092
3.75	-98.3	-616	.079
4.00	-86.3	-442	.069
4.25	-84.1	-448	.061
4.50	-85.1	-454	.054
4.75	-87.9	-458	.049
5.00	-92.8	-462	.044
5.25	-104	-466	.040
5.50	-101	-289	.036
5.75	-93.3	-293	.033
6.00	-89.9	-295	.030
6.50	-86.6	-300	.026
7.00	-85.1	-305	.022
8.00	-84.1	-312	.017
9.00	-84.3	-317	.013
10.0	-84.9	-321	.011

1. Normalized Group Delay:

The above delay data is normalized to a corner frequency of 1.0Hz. The actual delay is the normalized delay divided by the actual corner frequency (fc).

$$\text{Actual Delay} = \frac{\text{Normalized Delay}}{\text{Actual Corner Frequency (fc) in Hz}}$$

Frequency Response

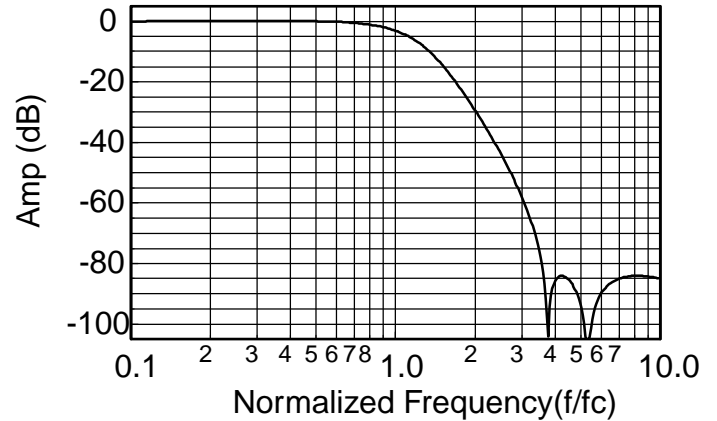

Delay (Normalized)

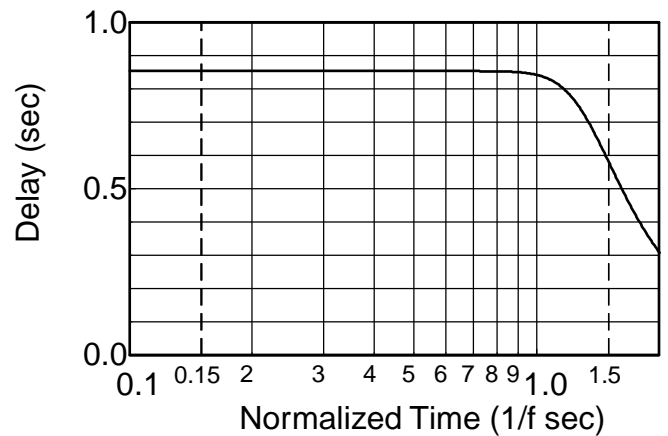

Step Response

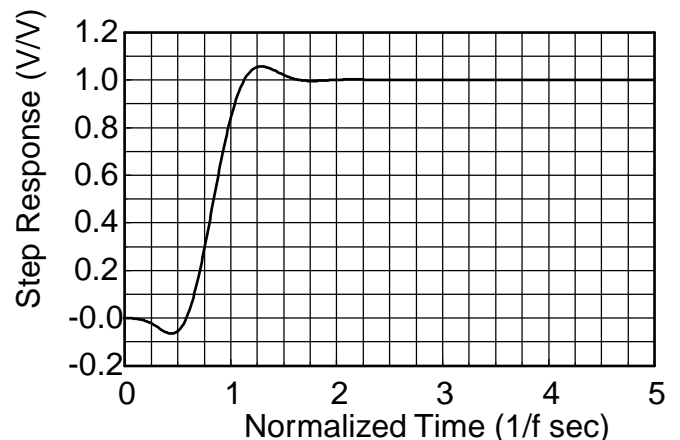



Theoretical Transfer Characteristics

f/fc (Hz)	Amp (dB)	Phase (deg)	Delay ¹ (sec)
0.00	0.00	0.00	.865
0.10	0.015	-31.1	.865
0.20	0.051	-62.3	.865
0.30	0.085	-93.4	.865
0.40	0.085	-125	.865
0.50	0.010	-156	.865
0.60	-0.182	-187	.865
0.70	-0.532	-218	.865
0.80	-1.09	-249	.864
0.85	-1.45	-265	.863
0.90	-1.89	-280	.861
0.95	-2.41	-296	.857
1.00	-3.01	-311	.851
1.10	-4.50	-341	.828
1.20	-6.38	-370	.785
1.40	-11.2	-422	.650
1.60	-16.8	-464	.504
1.80	-22.5	-496	.389
2.00	-28.0	-520	.306
2.25	-34.5	-544	.235
2.50	-40.5	-563	.186
2.75	-46.1	-578	.151
3.00	-51.4	-591	.125
3.50	-61.5	-610	.090
4.00	-71.2	-624	.068
4.50	-81.3	-635	.054
5.00	-93.4	-643	.043
5.50	-142	-651	.036
6.00	-105	-476	.030
6.20	-105	-478	.028
6.50	-106	-481	.025
7.00	-110	-486	.022
8.00	-122	-312	.017
9.00	-109	-318	.013
10.0	-106	-322	.011
12.0	-105	-328	.007
14.0	-106	-333	.005
16.0	-107	-336	.004
18.0	-108	-339	.003
20.0	-109	-341	.003

1. Normalized Group Delay:

The above delay data is normalized to a corner frequency of 1.0Hz. The actual delay is the normalized delay divided by the actual corner frequency (fc).

$$\text{Actual Delay} = \frac{\text{Normalized Delay}}{\text{Actual Corner Frequency (fc) in Hz}}$$

Frequency Response

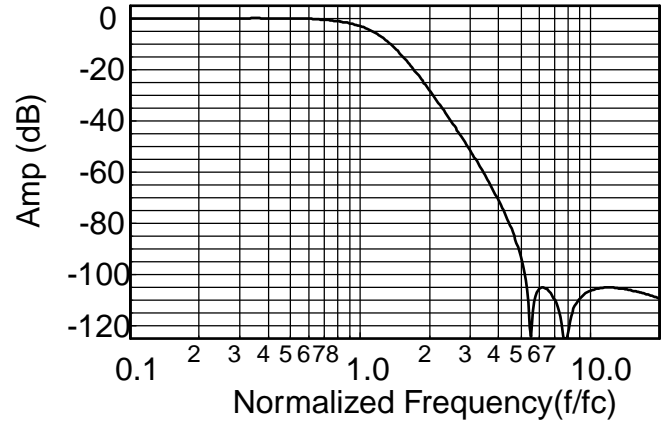

Delay (Normalized)

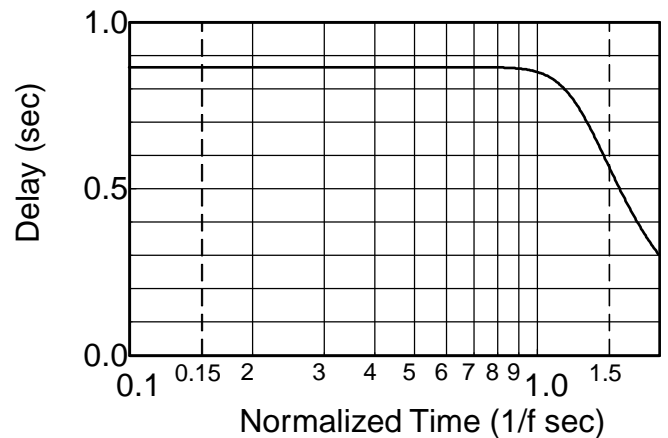

Step Response

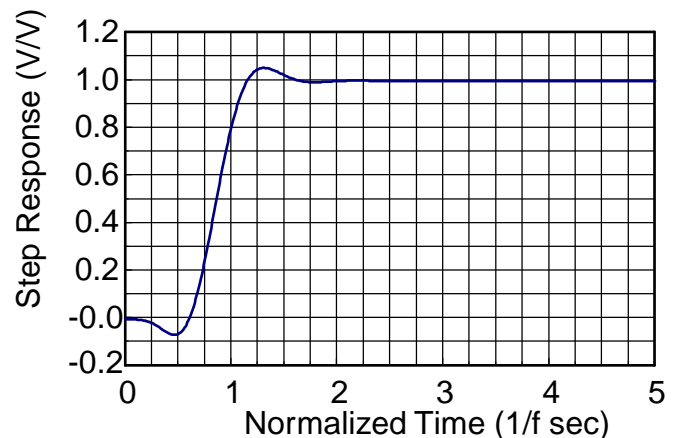



Appendix A

Theoretical Transfer Characteristics

f/fc (Hz)	Amp (dB)	Phase (deg)	Delay ¹ (sec)
0.00	0.00	0.00	0.823
0.10	-0.001	-29.7	0.829
0.20	-0.013	-59.8	0.844
0.30	-0.040	-90.5	0.865
0.40	-0.049	-122	0.904
0.50	-0.018	-156	0.972
0.55	-0.003	-174	1.016
0.60	-0.002	-192	1.064
0.65	-0.019	-212	1.116
0.70	-0.042	-233	1.178
0.75	-0.049	-255	1.264
0.80	-0.026	-279	1.388
0.85	-0.001	-305	1.557
0.90	-0.024	-335	1.767
0.95	-0.045	-369	2.111
1.00	-0.050	-414	3.062
1.10	-10.48	-531	2.043
1.20	-25.96	-576	0.814
1.30	-39.45	-598	0.493
1.40	-52.87	-614	0.348
1.50	-69.11	-624	0.265
1.60	-89.09	-453	0.211
1.70	-85.32	-459	0.174
1.75	-89.95	-463	0.156
1.80	-103.5	-465	0.147
1.85	-95.94	-288	0.158
1.90	-89.31	-290	0.126
1.95	-86.44	-292	0.117
2.00	-84.96	-295	0.110
2.20	-84.54	-302	0.087
2.40	-88.65	-307	0.069
2.60	-99.78	-311	0.057
2.80	-99.97	-135	0.048
3.00	-90.20	-139	0.041
3.50	-85.09	-145	0.029
4.00	-84.04	-150	0.022
5.00	-84.76	-156	0.014
6.00	-86.45	-160	0.009
7.00	-88.31	-163	0.007
8.00	-90.11	-165	0.005
9.00	-91.82	-167	0.004
10.0	-93.41	-168	0.003

1. Normalized Group Delay:

The above delay data is normalized to a corner frequency of 1.0Hz. The actual delay is the normalized delay divided by the actual corner frequency (fc).

$$\text{Actual Delay} = \frac{\text{Normalized Delay}}{\text{Actual Corner Frequency (fc) in Hz}}$$

Frequency Response

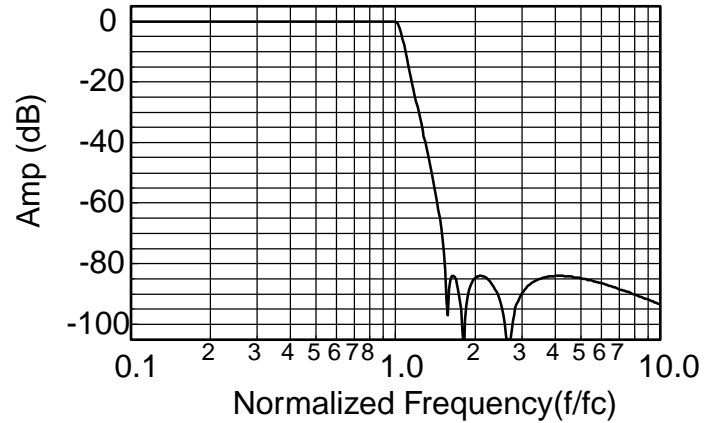

Delay (Normalized)

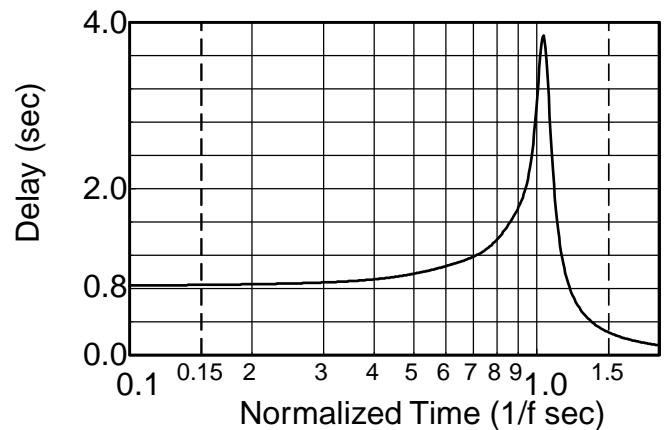

Step Response

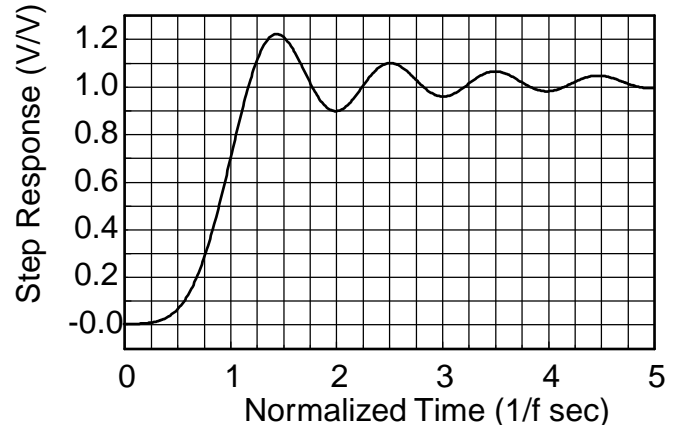



Appendix A

Theoretical Transfer Characteristics

f/fc (Hz)	Amp (dB)	Phase (deg)	Delay ¹ (sec)
0.00	0.00	0.00	0.713
0.10	-0.004	-25.7	0.716
0.20	-0.014	-51.6	0.724
0.30	-0.024	-77.9	0.740
0.40	-0.020	-105	0.767
0.50	0.007	-133	0.811
0.55	0.022	-148	0.840
0.60	0.033	-163	0.872
0.65	0.031	-179	0.908
0.70	0.014	-196	0.946
0.75	-0.015	-213	0.989
0.80	-0.041	-232	1.04
0.85	-0.046	-251	1.12
0.90	-0.016	-272	1.23
0.95	-0.025	-296	1.40
1.00	-0.035	-323	1.65
1.10	-1.76	-392	2.14
1.20	-8.28	-467	1.86
1.30	-18.4	-522	1.19
1.40	-29.3	-558	0.753
1.50	-40.1	-578	0.517
1.60	-51.5	-594	0.381
1.70	-65.2	-606	0.296
1.75	-75.0	-611	0.265
1.80	-113.0	-616	0.239
1.85	-83.6	-440	0.217
1.90	-82.0	-444	0.198
1.95	-83.7	-447	0.182
2.00	-87.8	-450	0.168
2.20	-85.8	-280	0.126
2.40	-82.0	-289	0.099
2.60	-83.5	-295	0.081
2.80	-88.2	-301	0.067
3.00	-99.9	-305	0.057
3.50	-87.2	-134	0.040
4.00	-83.1	-140	0.030
5.00	-82.1	-148	0.018
6.00	-83.1	-154	0.013
7.00	-84.6	-157	0.009
8.00	-86.2	-160	0.007
9.00	-87.8	-163	0.005
10.0	-89.3	-164	0.004

1. Normalized Group Delay:

The above delay data is normalized to a corner frequency of 1.0Hz. The actual delay is the normalized delay divided by the actual corner frequency (fc).

$$\text{Actual Delay} = \frac{\text{Normalized Delay}}{\text{Actual Corner Frequency (fc) in Hz}}$$

Frequency Response

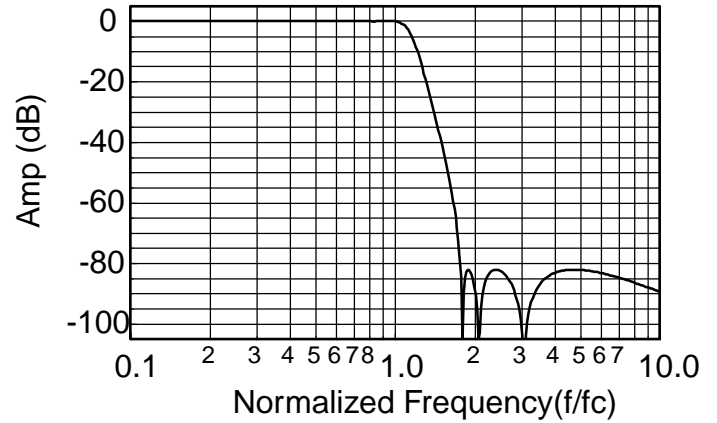

Delay (Normalized)

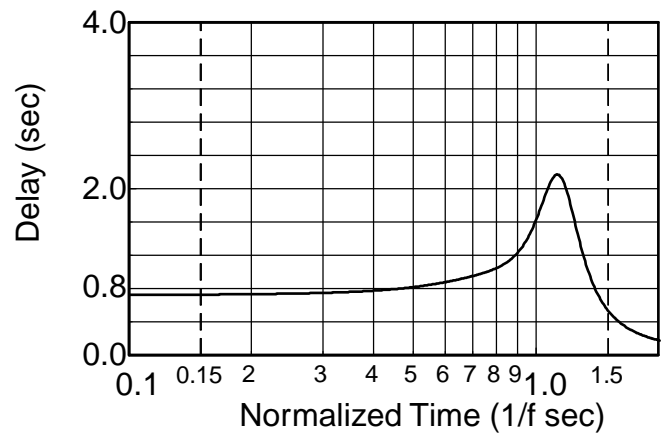

Step Response

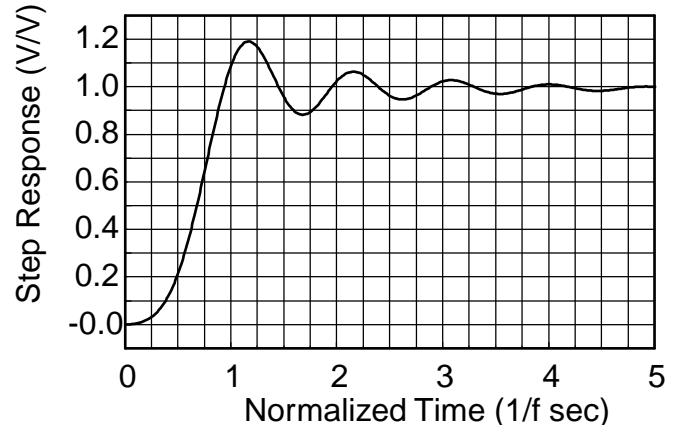



Appendix A

Theoretical Transfer Characteristics

f/fc (Hz)	Amp (dB)	Phase (deg)	Delay ¹ (sec)
0.00	0.00	0.00	0.885
0.10	-0.001	-31.9	0.891
0.20	-0.015	-64.2	0.903
0.30	-0.040	-97.0	0.922
0.40	-0.042	-131	0.958
0.50	-0.001	-166	1.020
0.55	0.000	-185	1.057
0.60	-0.007	-204	1.099
0.65	-0.027	-225	1.140
0.70	-0.045	-245	1.193
0.75	-0.040	-268	1.269
0.80	-0.014	-291	1.377
0.85	-0.001	-317	1.513
0.90	-0.031	-346	1.677
0.95	-0.036	-378	1.960
1.00	-0.046	-419	2.681
1.10	-7.910	-525	2.127
1.20	-21.06	-573	0.856
1.30	-31.96	-597	0.509
1.40	-41.51	-612	0.357
1.50	-50.35	-623	0.271
1.60	-58.90	-632	0.216
1.70	-67.54	-639	0.177
1.75	-72.04	-642	0.162
1.80	-76.79	-645	0.149
1.85	-81.93	-647	0.138
1.90	-87.78	-650	0.128
1.95	-95.04	-652	0.119
2.00	-106.6	-654	0.111
2.20	-106.0	-481	0.087
2.40	-121.3	-307	0.070
2.60	-106.5	-311	0.058
2.80	-105.0	-315	0.049
3.00	-106.4	-318	0.042
3.50	-123.6	-325	0.030
4.00	-111.5	-149	0.022
5.00	-105.4	-156	0.014
6.00	-105.1	-160	0.010
7.00	-106.0	-163	0.007
8.00	-107.3	-165	0.005
9.00	-108.6	-167	0.004
10.0	-110.0	-168	0.003

1. Normalized Group Delay:

The above delay data is normalized to a corner frequency of 1.0Hz. The actual delay is the normalized delay divided by the actual corner frequency (fc).

$$\text{Actual Delay} = \frac{\text{Normalized Delay}}{\text{Actual Corner Frequency (fc) in Hz}}$$

Frequency Response

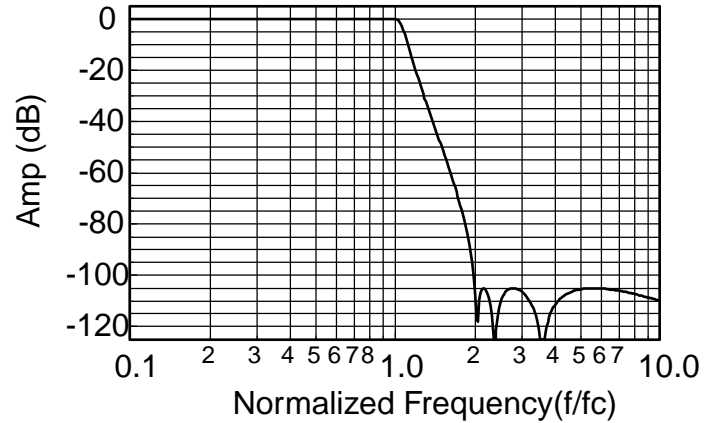

Delay (Normalized)

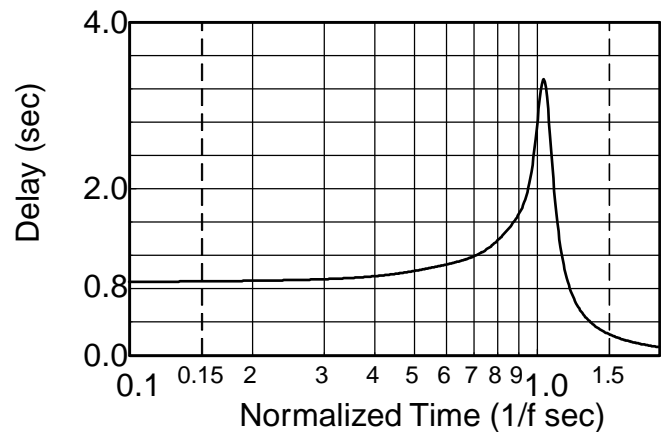

Step Response

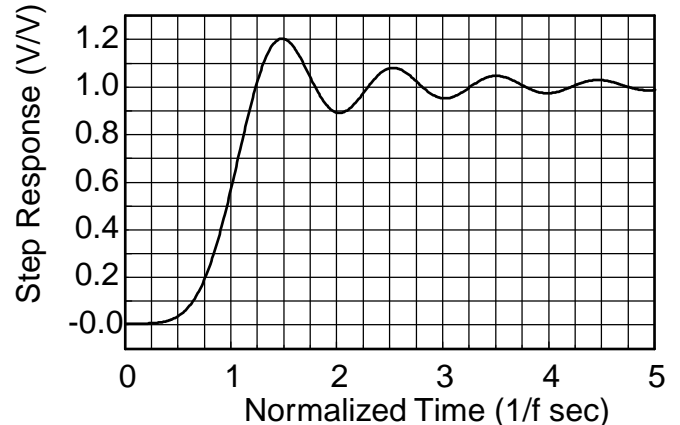



Theoretical Transfer Characteristics

f/fc (Hz)	Amp (dB)	Phase (deg)	Delay¹ (sec)
0.10	-160	691	0.819
0.20	-112	661	0.828
0.30	-83.7	631	0.843
0.40	-63.7	600	0.867
0.50	-48.2	568	0.903
0.60	-35.5	535	.956
0.70	-24.8	499	1.04
0.80	-15.6	459	1.19
0.85	-11.6	437	1.29
0.90	-8.06	413	1.40
0.95	-5.15	386	1.48
1.00	-3.01	360	1.46
1.20	-0.229	275	0.873
1.40	-0.020	226	0.540
1.60	-0.002	194	0.380
1.80	0.00	170	0.287
2.00	0.00	152	0.226
2.50	0.00	120	0.139
3.00	0.00	99.2	0.094
4.00	0.00	74.0	0.052
5.00	0.00	59.0	0.033
6.00	0.00	49.0	0.023
7.00	0.00	42.1	0.017
8.00	0.00	36.8	0.013
9.00	0.00	32.7	0.010
10.0	0.00	29.4	0.008

Frequency Response

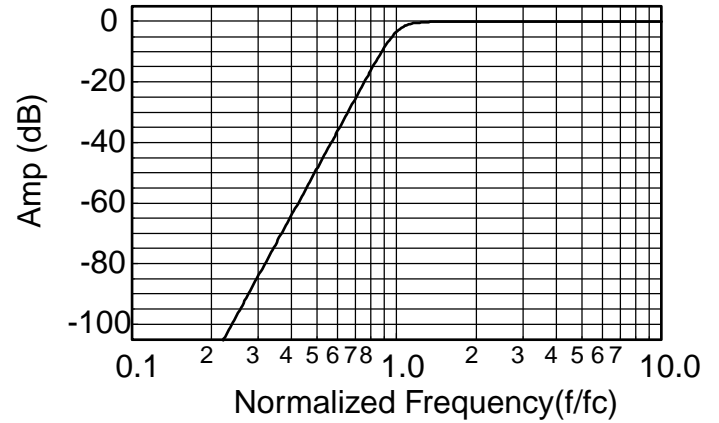

1. Normalized Group Delay:

The above delay data is normalized to a corner frequency of 1.0Hz. The actual delay is the normalized delay divided by the actual corner frequency (fc).

$$\text{Actual Delay} = \frac{\text{Normalized Delay}}{\text{Actual Corner Frequency (fc) in Hz}}$$



Appendix A

Theoretical Transfer Characteristics

f/fc (Hz)	Amp (dB)	Phase (deg)	Delay ¹ (sec)
0.10	-93.4	168	0.334
0.20	-84.8	156	0.344
0.30	-86.0	143	0.363
0.40	-92.6	310	0.392
0.50	-85.0	295	0.439
0.55	-114	287	0.472
0.60	-84.1	458	0.515
0.70	-57.0	617	0.652
0.80	-32.8	589	0.962
0.85	-22.6	569	1.325
0.90	-12.3	538	2.198
0.95	-3.08	483	3.993
1.00	-0.05	414	3.062
1.10	-0.03	341	1.498
1.20	-0.01	296	1.039
1.30	-0.04	264	0.773
1.40	-0.05	239	0.612
1.50	-0.03	219	0.505
1.60	-0.01	202	0.426
1.70	0.00	188	0.364
1.80	0.00	176	0.315
1.90	-0.01	165	0.275
2.00	-0.02	156	0.243
2.50	-0.05	122	0.145
3.00	-0.05	101	0.097
4.00	-0.03	75.1	0.053
5.00	-0.01	59.8	0.034
6.00	-0.01	49.7	0.023
7.00	0.00	42.5	0.017
8.00	0.00	37.2	0.013
9.00	0.00	33.0	0.010
10.0	0.00	29.7	0.008

Frequency Response

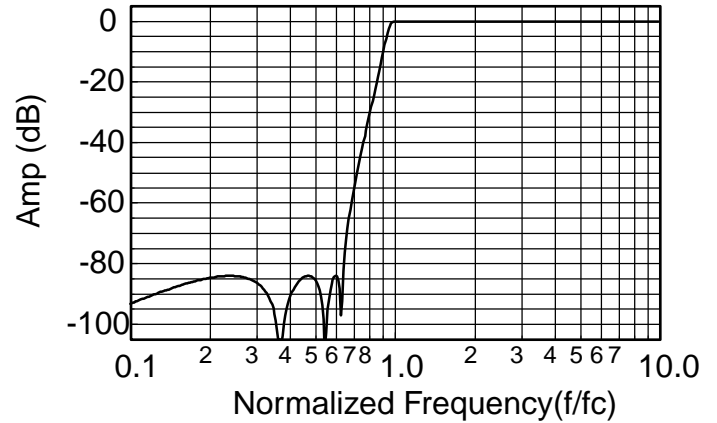

1. Normalized Group Delay:

The above delay data is normalized to a corner frequency of 1.0Hz. The actual delay is the normalized delay divided by the actual corner frequency (fc).

$$\text{Actual Delay} = \frac{\text{Normalized Delay}}{\text{Actual Corner Frequency (fc) in Hz}}$$



Theoretical Transfer Characteristics

f/fc (Hz)	Amp (dB)	Phase (deg)	Delay ¹ (sec)
0.10	-89.3	164	0.440
0.20	-82.1	148	0.459
0.30	-90.6	131	0.495
0.40	-82.4	292	0.559
0.50	-87.8	450	0.671
0.55	-90.0	437	0.761
0.60	-60.2	603	0.890
0.70	-32.4	563	1.37
0.80	-13.1	498	2.35
0.85	-6.28	451	2.77
0.90	-2.21	401	2.66
0.95	-0.51	358	2.15
1.00	-0.03	324	1.64
1.10	-0.01	277	1.04
1.20	-0.05	225	0.757
1.30	-0.03	221	0.596
1.40	0.01	201	0.486
1.50	0.03	185	0.409
1.60	0.03	172	0.347
1.70	0.03	160	0.299
1.80	0.02	150	0.260
1.90	0.01	141	0.229
2.00	0.01	133	0.203
2.50	-0.02	105	0.123
3.00	-0.02	86.9	0.083
4.00	-0.02	64.7	0.046
5.00	-0.01	51.6	0.029
6.00	-0.01	42.9	0.020
7.00	-0.01	36.8	0.015
8.00	-0.01	32.1	0.011
9.00	-0.01	28.6	0.009
10.0	0.00	25.7	0.007

Frequency Response

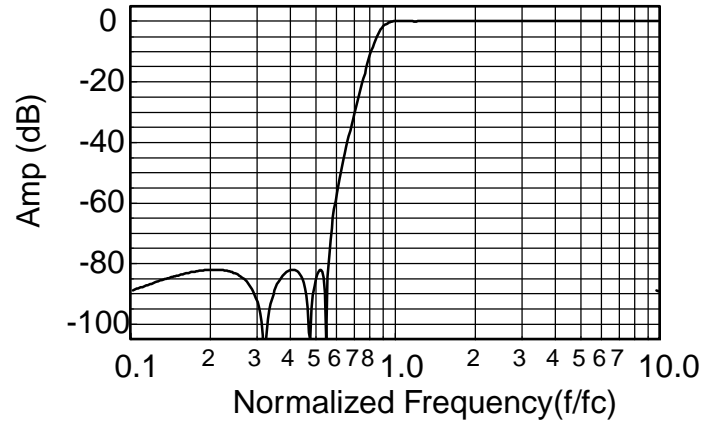

1. Normalized Group Delay:

The above delay data is normalized to a corner frequency of 1.0Hz. The actual delay is the normalized delay divided by the actual corner frequency (fc).

$$\text{Actual Delay} = \frac{\text{Normalized Delay}}{\text{Actual Corner Frequency (fc) in Hz}}$$



Appendix A

Theoretical Transfer Characteristics

f/fc (Hz)	Amp (dB)	Phase (deg)	Delay ¹ (sec)
0.10	-110	168	0.338
0.20	-105	156	0.348
0.30	-114	323	0.367
0.40	-110	309	0.397
0.50	-107	654	0.445
0.55	-78.6	646	0.480
0.60	-64.6	637	0.524
0.70	-44.1	615	0.669
0.80	-26.7	586	1.001
0.85	-18.2	565	1.401
0.90	-9.46	533	2.315
0.95	-2.16	478	3.604
1.00	-0.046	419	2.681
1.10	-0.038	352	1.416
1.20	-0.001	308	1.018
1.30	-0.032	277	0.773
1.40	-0.046	252	0.618
1.50	-0.034	231	0.514
1.60	-0.016	214	0.436
1.70	-0.004	200	0.376
1.80	0.000	187	0.328
1.90	-0.003	176	0.288
2.00	-0.010	166	0.255
2.50	-0.042	131	0.153
3.00	-0.045	108	0.103
4.00	-0.028	80.6	0.057
5.00	-0.015	64.2	0.036
6.00	-0.008	53.4	0.025
7.00	-0.005	45.7	0.018
8.00	-0.003	40.0	0.014
9.00	-0.002	35.5	0.011
10.0	-0.001	31.9	0.009

Frequency Response

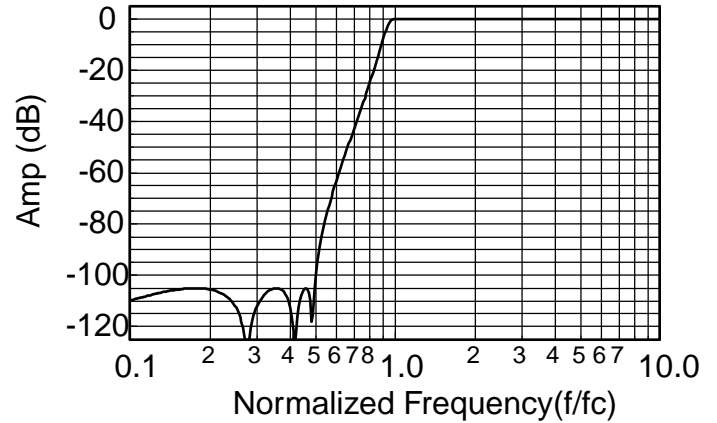

1. Normalized Group Delay:

The above delay data is normalized to a corner frequency of 1.0Hz. The actual delay is the normalized delay divided by the actual corner frequency (fc).

$$\text{Actual Delay} = \frac{\text{Normalized Delay}}{\text{Actual Corner Frequency (fc) in Hz}}$$